



**MCOTS-N-28V-60-EP**  
**Single Output**  
**Eighth-brick**

## Military COTS Non-Isolated DC-DC Converters

<b>9-60V</b> Continuous Input	<b>0 - 60V</b> Output	<b>15A</b> Current	<b>Non-Isolated</b>	<b>Eighth-brick</b> DC-DC Converter
----------------------------------	--------------------------	-----------------------	---------------------	--

The MCOTS NiQor® eighth-brick dc-dc converter is a non-isolated buck-boost regulator, which employs synchronous rectification to achieve extremely high conversion efficiency. The High Input Voltage MCOTS NiQor Brick family of converters can be used in traditional DPA (distributed power architecture) systems or provide a regulated output voltage from a battery source or other variable voltage source. The MCOTS NiQor Brick family can be configured to Buck the input voltage down to a lower voltage or Boost the input voltage up to a higher voltage using a single external resistor. The module is RoHS 6/6 compliant (see last page).

*Mil***COTS**™



**Designed and manufactured in the USA.**

### Operational Features

- High efficiency, 96% at full rated load current
- Delivers up to 15A of output current
- Input Voltage Range: 9-60Vdc
- Output Voltage Range: 0 - 60V (negative output is possible)
- Extensive on-board input and output filtering
- No minimum load requirement means no preload resistors required
- Adjustable current limit with current monitor

### Protection Features

- Input under-voltage lockout protects the converter at low input voltage conditions
- Over-current shutdown protects converter from excessive load current or short circuits
- Input/output over-voltage protection protects load and regulator from damaging voltages
- Thermal shutdown protects converter from abnormal environmental conditions

### Screening/Qualification

- AS9100 and ISO 9001 certified facility
- Qualified to MIL-STD-810
- Available with S-Grade or M-Grade screening
- Pre-cap inspection per IPC-A-610, Class III
- Temperature cycling per MIL-STD-883, Method 1010, Condition B, 10 cycles
- Burn-In at 100 °C baseplate temperature
- Final visual inspection per MIL-STD-883, Method 2009
- Full component traceability

### Control Features

- On/Off control
- Output voltage trim permits custom voltages
- Settable current limit
- Output voltage trim range of 0V - 60V

### Mechanical Features

- Industry standard eighth-brick pin-out configuration
- Standard size: .99" x 2.39" (25 x 60.6 mm)
- Total height only 0.500" (12.7 mm), permits better airflow and smaller card pitch

### Contents

	Page No.
Technical Specification . . . . .	.2
Application Section . . . . .	.7
Standard Mechanical Diagram . . . . .	.10
Flanged Mechanical Diagram . . . . .	.11
Qualifications & Screening . . . . .	.12
Ordering Information . . . . .	.13



**MCOTS-N-28V-60-EP**  
**Output: 0 - 60V**  
**Current: 15A**

## MCOTS-N-28V-60-EP Electrical Characteristics

Ta = 25 °C, airflow rate = 300 LFM, Vin = 28 V dc unless otherwise noted; full operating temperature range is -55 °C to +100 °C baseplate temperature with appropriate power derating. Specifications subject to change without notice.

Parameter	Vout	Min.	Typ.	Max.	Units	Notes & Conditions
<b>ABSOLUTE MAXIMUM RATINGS</b>						
Input Voltage						
Non-Operating	All	-1		80	V	Continuous
Operating	All			60	V	Continuous
Isolation Voltage						
Input to Baseplate				1150	Vdc	
Output to Baseplate				1150	Vdc	
Storage Temperature	All	-65		125	°C	
Voltage at ON/OFF input pin	All	0		5.5	V	
Voltage at Vset and Iset Pins		-0.2		3.5	V	Note 1
<b>RECOMMENDED OPERATING CONDITIONS</b>						
Input Voltage Range	All	9		60	V	Turn on at 10V
Input Fuse Rating	All			25	A	Fast blow external fuse recommended
Input Current				15	A	Input current max equals output rated current
External Input Capacitance	28	470			µF	ESR > 50 mΩ See Note 2
Output Voltage	All	0		60	V	
Output Current	All	0		15	A	Input voltage dependent
<b>INPUT CHARACTERISTICS</b>						
Input Under-Voltage Lockout						
Turn-On Voltage Threshold	All	9.2	9.5	10	V	
Turn-Off Voltage Threshold	All	5.1	5.6	6.1	V	
Lockout Hysteresis	All		4.0		V	
Input Current Limit	All			18.0	A	
No-Load Input Current	12		115		mA	
"	28		115		mA	
"	48		210		mA	
Disabled Input Current	All		0.8		mA	
Input Filter Components Value (L\C)	All		0.68\33.0		µH\µF	
<b>OUTPUT CHARACTERISTICS</b>						
Output Voltage Range	All	0		60	V	Set by Vset resistor
Operating Output Current Range	All	0		15	A	
Output Voltage Regulation						
Load Regulation	All	-2%*Vout*Iout/Imax				
Total Output Voltage Range	All	±100mV ±2%*Vout + Load Reg				Between Sense pins, over sample, line, load, temp. & life.
Output Voltage Ripple and Noise (pk-pk/28Vin)	12		100		mV	28 Vin Full Load; 100uF; 20 MHz b.w.
"	28		300		mV	"
"	48		200		mV	"
Output DC Over Current limit	All		18.0		A	Effective on input, output condition
External Output Capacitance	All	100			µF	ESR > 1 mΩ
Output Filter Components (C\L)	All		36.3\ 0.68		µF\µH	
Reverse Current	All		1		µA	Disabled
<b>DYNAMIC CHARACTERISTICS</b>						
Output Voltage during Current Transient						
For a Step Change in Output Current	12		700		mV	(0.1 A/µs); 50%-75%-50% Iout max
Settling Time	12		300		us	To within 1.5% Vout nom.
For a Step Change in Output Current	48		1000		mV	(0.1 A/µs); 50%-75%-50% Iout max
Settling Time	48		700		us	To within 1.5% Vout nom.
Turn on Transient						
Startup delay	All		2		ms	Resistive load
Rise Rate	All		1.6		V/ms	"
Output Voltage Overshoot	All		0		V	"

## MCOTS-N-28V-60-EP Electrical Characteristics (continued)

Ta = 25 °C, airflow rate = 300 LFM, Vin = 28 V dc unless otherwise noted; full operating temperature range is -55 °C to +100 °C baseplate temperature with appropriate power derating. Specifications subject to change without notice.

Parameter	Vout	Min.	Typ.	Max.	Units	Notes & Conditions
<b>EFFICIENCY</b>						
100% Load; 24 Vin	12		94		%	
100% Load; 48 Vin	24		95		%	
100% Load; 12 Vin	48		91		%	
50% Load; 24 Vin	12		94		%	
50% Load; 48 Vin	24		95		%	
50% Load; 12 Vin	48		91		%	
<b>FEATURE CHARACTERISTICS</b>						
Switching Frequency	All	240	250	260	KHz	
On/Off, Negative (N) Logic						See REMOTE ON/OFF: in CONTROL FEATURES
Off-State Threshold Voltage	All		1.4	1.5	V	
On-State Threshold Voltage	All	1.0	1.1		V	
Threshold Hysteresis	All		0.3		V	
Pin Pull-Up Voltage	All		5.0		V	
Pin Pull-Up Resistance	All		25		kΩ	
Output Voltage Setpoint						See OUTPUT VOLTAGE SETPOINT: in CONTROL FEATURES
Pin Pull-Up Voltage	All		2.5		V	
Pin Pull-Up Resistance	All		10.9		kΩ	
Output Voltage Setpoint Range	All	0		60	V	
Output Over-Voltage Shutdown	All		65		V	Fixed - Does not vary with output setpoint
Output Current Setpoint						See OUTPUT CURRENT SETPOINT: in CONTROL FEATURES
Pin Pull-Up Voltage	All		2.5		V	
Pin Pull-Up Resistance	All		10		kΩ	
Output Current Setpoint Range	All	0		15	A	
Input/Output Current Limit	All	16	18	20	A	
<b>Imon</b>						
Pin Voltage at No Load	All		0.2		V	
Pin Voltage at Full Load (Imax)	All		2.2		V	
Pin Output Resistance	All		2.5		kΩ	
Over-Temperature Shutdown	All		115		°C	Average PCB Temperature
Over-Temperature Shutdown Restart Hysteresis	All		15		°C	
<b>RELIABILITY CHARACTERISTICS</b>						
Calculated MTBF (TR-NWT-000332; Telcordia)	All		3.6		10 <sup>6</sup> Hrs.	70 °C Tbaseplate
Calculated MTBF (MIL-HDBK-217F; MIL-217)	All		3.2		10 <sup>6</sup> Hrs.	70 °C Tbaseplate
<b>TEMP LIMITS FOR POWER DERATING</b>						
Semiconductor Junction Temperature	All			125	°C	Package rated to 150 °C
Board Temperature	All			125	°C	UL rated max operating temp 130 °C
Baseplate Temperature	All			100	°C	

Note 1: All control signals are referenced to -Vout pin.

Note 2: Input capacitance and ESR of input capacitance dictated by input stability requirements. For Vin << Nom Vin and/or Vout >> Nom Vout, consult SynQor Field Applications.

Please see SynQor Application Note: [http://www.synqor.com/documents/appnote/appnt\\_System\\_Instability.pdf](http://www.synqor.com/documents/appnote/appnt_System_Instability.pdf)





## Technical Charts

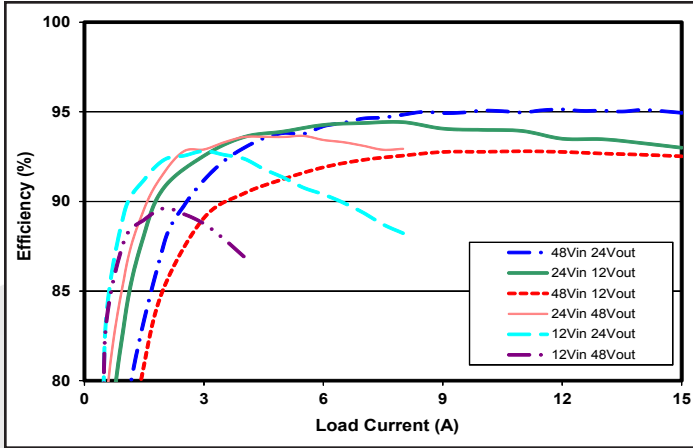

Figure 1: Efficiency at different output voltages vs. load current for different input voltages at 25°C.

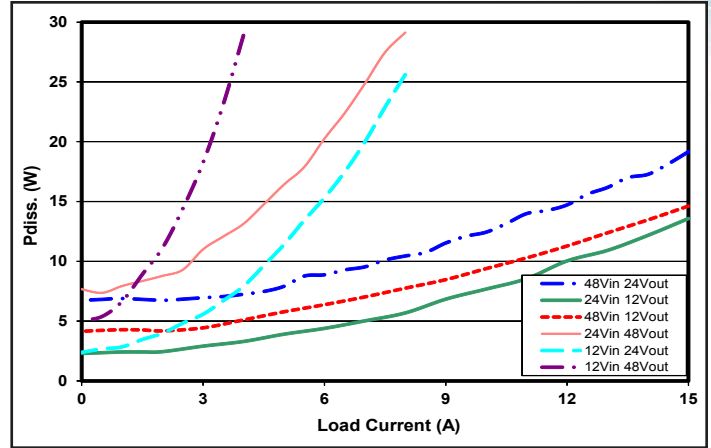

Figure 2: Power dissipation at different output voltages vs. load current for different input voltages at 25°C.

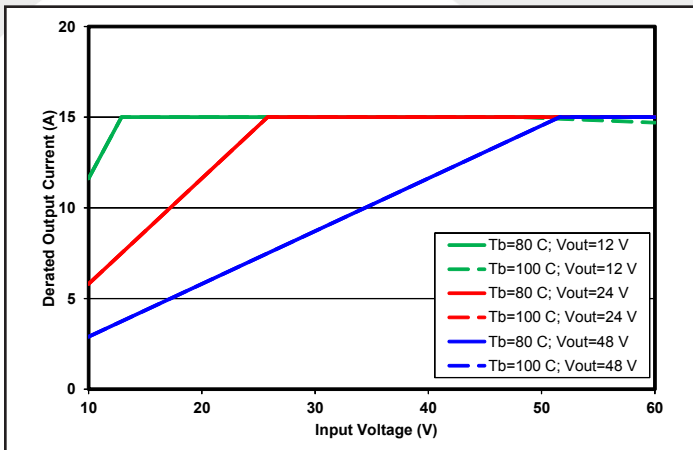

Figure 3: Maximum output power derating curve with a controlled baseplate temperature of 80°C and 100°C vs. Input voltage.

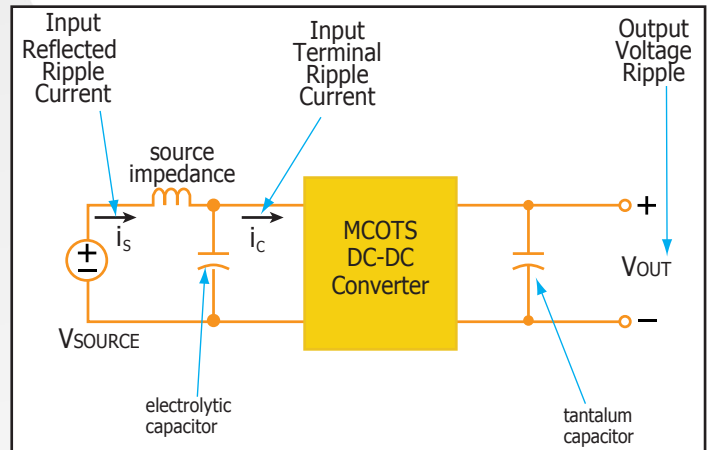

Figure 4: Test set-up diagram showing measurement points for Input Terminal Ripple Current (Fig 5) and Output Voltage Ripple (Fig 6).

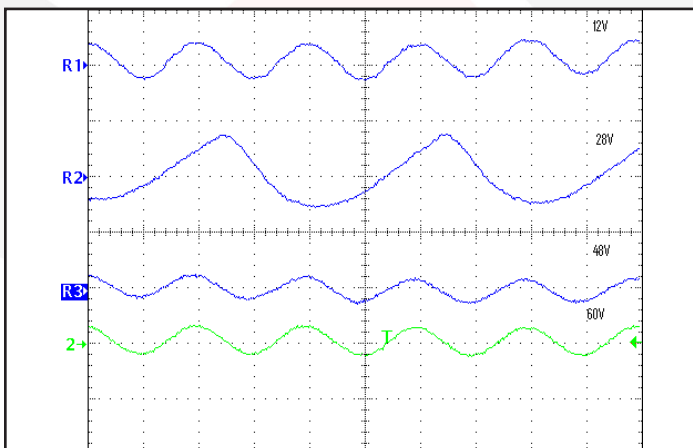

Figure 5: Input Terminal Ripple Current at 28V input and rated load current (500mA/div). Load capacitance: 100uF electrolytic cap. Bandwidth: 20MHz, (2uS/div). See Figure 4

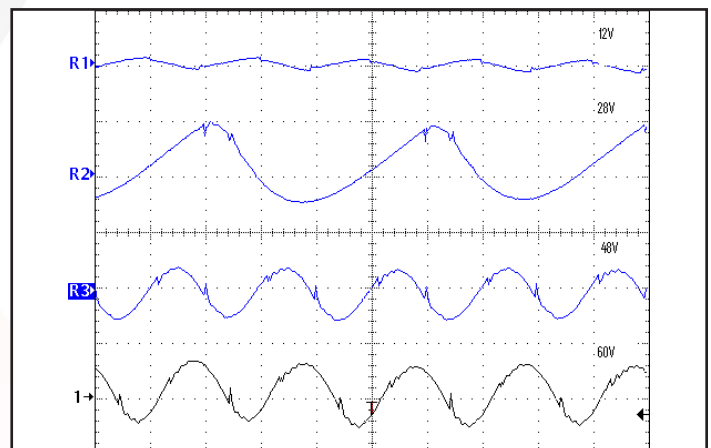

Figure 6: Output Voltage Ripple at 28V input and rated load current (200mV/div). Load capacitance: 100uF electrolytic cap. Bandwidth: 20MHz, (2uS/div). See Figure 4.



# Technical Charts

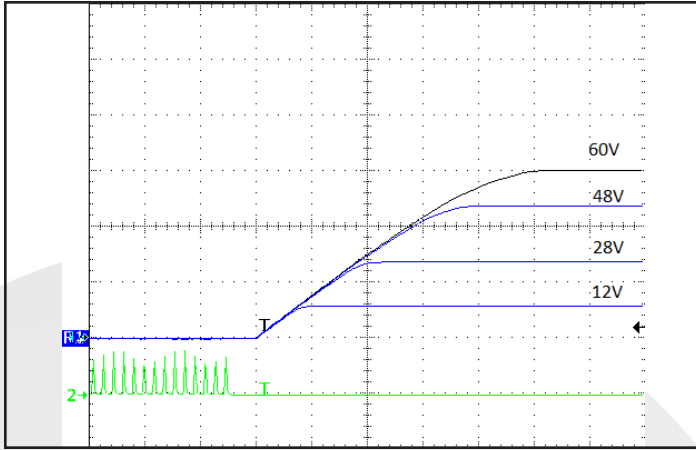

Figure 7: Turn-on transient at 28V input; full load (10ms/div). Top Traces: Vout (20V/div). Bottom Trace: ON/OFF input (5V/div)

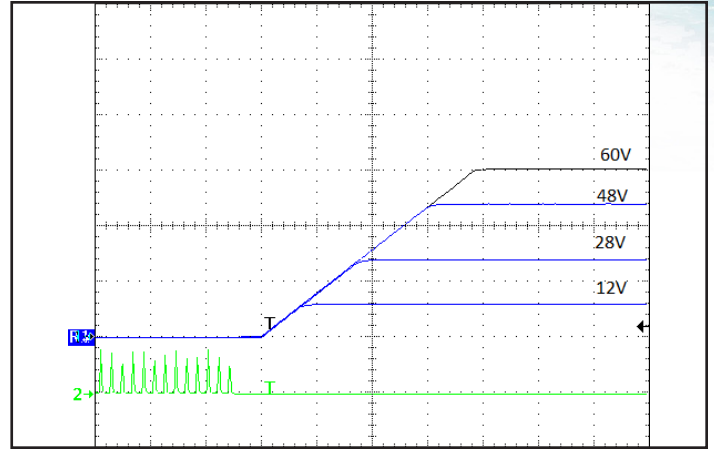

Figure 8: Turn-on transient at 28V input; zero load (10ms/div). Top Traces: Vout (20V/div). Bottom Trace: ON/OFF input (5V/div)

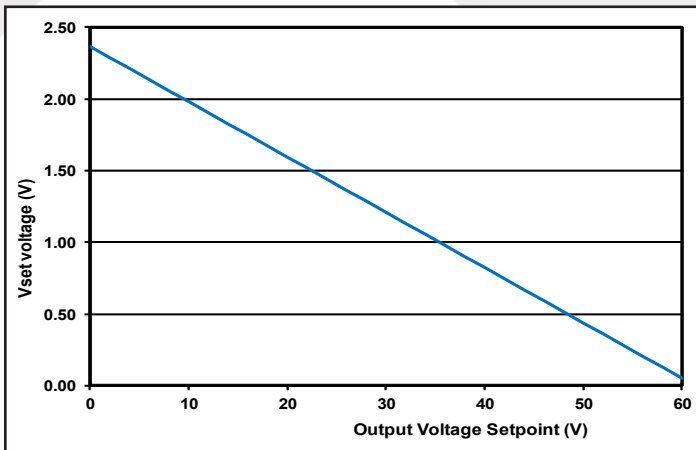

Figure 9: Vset pin voltage vs. Output Voltage Setpoint.

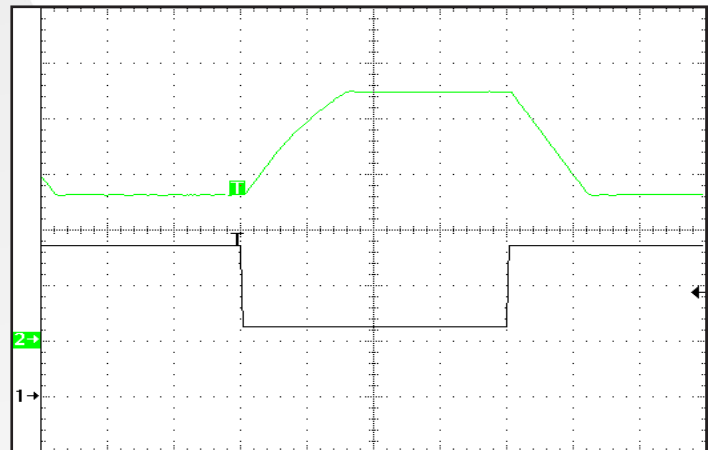

Figure 10: Output Voltage vs. Vset pin voltage dynamics; 28Vin, 10A out (5mS/div). Bottom trace: Vset pin voltage (500mV/div). Top trace: Output Voltage (10V/div).

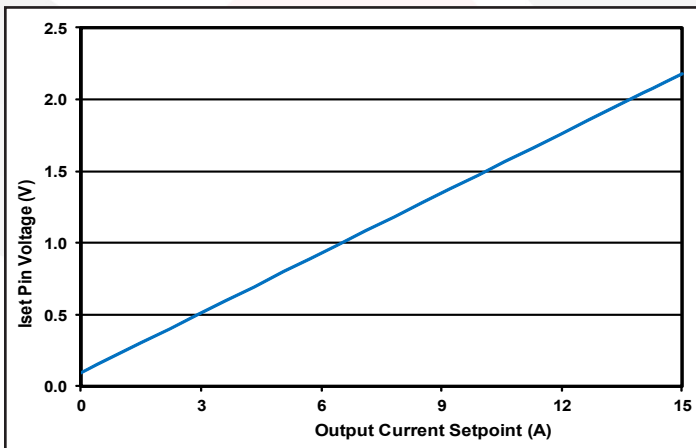

Figure 11: Iset pin voltage vs. Output Current Limit Setpoint.

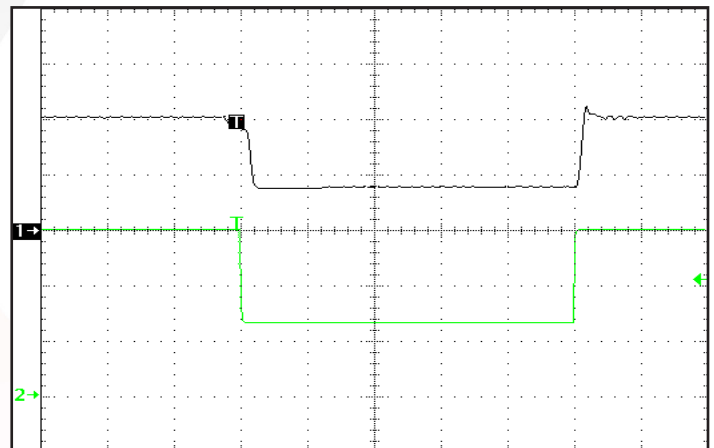

Figure 12: Output Current vs Iset pin voltage dynamics; 28Vin 5Vout (5mS/div). Top Trace: Output Current (5A/div). Bottom Trace: Iset pin voltage (500mV/div).



## Technical Charts

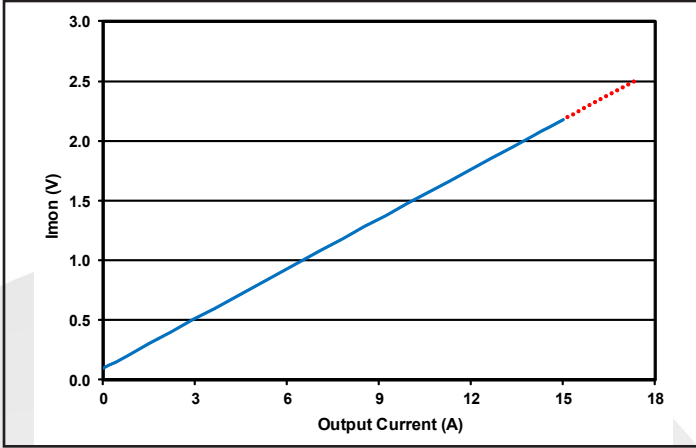

Figure 13: I<sub>mon</sub> pin Voltage vs. Output Load Current.

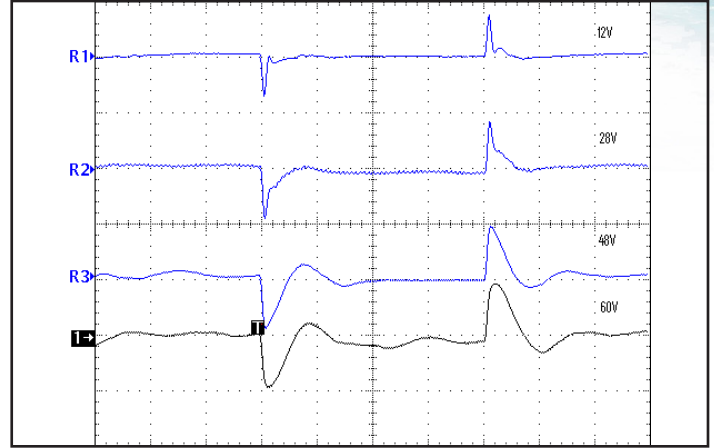

Figure 14: Output voltage response for 28V input; 12V, 28V, 48V, 60V output to step change in load current (50%-75%-50% of I<sub>out</sub> max; di/dt=0.1A/uS). Load cap: 100uF electrolytic cap, V<sub>out</sub> (1V/div); (500uS/div)

## STANDARDS COMPLIANCE

Parameter	Notes & Conditions
<b>STANDARDS COMPLIANCE</b>	
UL 62368-1	
EN 62368-1	
CAN/CSA-C22.2 No. 60950-1	

Note: An external input fuse must always be used to meet these safety requirements.

Contact SynQor for official safety certificates on new releases or download from the SynQor website.



## Application Section

### BASIC OPERATION AND FEATURES

This converter consists of integrated buck and boost converters, both controlled simultaneously by a digital controller. It automatically changes operating mode (buck mode or boost) when the line voltage or output set point changes. Very high efficiency is maintained over wide input and output ranges by shifting operational modes and use of synchronous rectifiers.

The converter runs at a fixed frequency with a predictable EMI performance.

This eighth-brick converter uses the industry standard footprint and pin-out configuration. A typical V-I characteristic, with  $V_{setpoint}=40V$  and  $I_{setpoint}=10A$ , when operating from  $V_{in}=20V$ , is shown in Figure A.

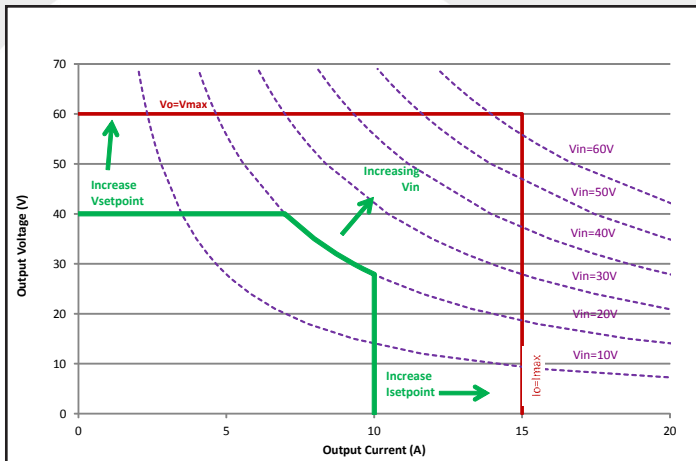

Figure A: V-I characteristics of MCOTS-N

### CONTROL FEATURES

**REMOTE ON/OFF:** Only Negative On/Off logic is available in the converter series: logic high at the input turns the converter Off while a logic low turns in On. Timing of this is shown in Figures 7, 8. A high level can be driven to any voltage between 1.5V and 3.3V, or simply left floating as the unit contains an internal 25KΩ pull-up to 5.0V. The pin can be pulled low (to  $V_{out-}$ ) by an optocoupler, an open-source/drain transistor or wired permanently to  $V_{out-}$ . To provide noise immunity the input has 0.3V of hysteresis.

Multiple units that have a common  $V_{out-}$  connection can be controlled by the same On/Off signal, but it is recommended that a small schottky diode be added to each input as shown in Figure B.

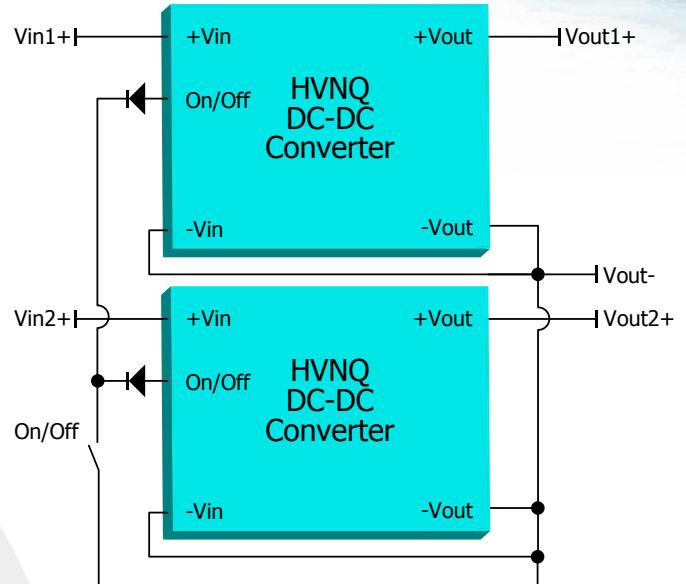

Figure B: Schematic for ON/OFF connection with multiple units

**OUTPUT VOLTAGE SETPOINT:** The output voltage can be programmed to any voltage between 0 V dc and  $V_{max}$  by connecting one resistor between the  $V_{set}$  pin (6) and  $V_{out-}$  (4); See Figure C. For a desired output voltage, the value of the resistor should be:

$$R_{vset}(V_{set}) = \left[ \left( \frac{11830 \times V_{max}}{V_{set} + 0.058 \times V_{max}} \right) - 10912 \right] (\Omega)$$



## Application Section

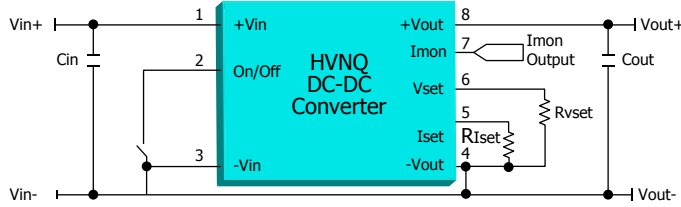

Figure C: Schematic for Vset and Iset connections

Alternatively, the Vset pin can be driven from an external voltage source: Undriven, this pin floats at 2.5V which sets the output to 0V. See Figure 10 for the large scale dynamics of this input.

$$V_{vset}(V_{set}) = 2.366 - 2.316 \left( \frac{V_{set}}{V_{max}} \right) \text{ (V)}$$

See Figure 9

where:

$$\begin{aligned} V_{set} &= \text{desired output voltage setpoint} \\ V_{max} &= \text{maximum rated output voltage (60V)} \end{aligned}$$

**OUTPUT CURRENT SETPOINT:** The maximum output current (effectively the current limit) can be reduced to any value between 0 and  $I_{max}$  by connecting one resistor between the Iset pin (5) and Vout- (4); see Figure C. The value of the resistor should be:

$$R_{Iset}(I_{set}) = \left[ \left( \frac{0.0469 I_{max} + I_{set}}{1.153 I_{max} - I_{set}} \right) * 10200 - 10 \right] \text{ (}\Omega\text{)}$$

Alternatively, the Iset pin can be driven from an external voltage source:

$$V_{iset}(I_{set}) = (0.0953 + 2.085 * I_{set}/I_{max}) \text{ V}$$

where:

$$\begin{aligned} I_{set} &= \text{desired output current setpoint} \\ I_{max} &= \text{maximum rated output current (15A)} \end{aligned}$$

Undriven, the Iset pin floats to 2.5V which sets the current limit at its nominal value of  $115% * I_{max}$ . See Figure 12 for the large signal dynamics of this control.

## PROTECTION FEATURES

**Input Under-Voltage Lockout:** The converter is designed to turn off when the input voltage is too low, helping avoid an input system instability problem, described in more detail in the application note titled "Input System Instability". The lockout circuitry is a comparator with DC hysteresis. When the input voltage is rising, it must exceed the typical Turn-On Voltage Threshold value (listed on the specification page) before the converter will turn on. Once the converter is on, the input voltage must fall below the typical Turn-Off Voltage Threshold value before the converter will turn off.

**Output Current Shutdown:** To provide protection in an output short condition, the unit is equipped with internal short circuit protection. When the short-circuit protection is triggered, the converter shuts down and then waits an inhibit time ( $\sim 100\text{ms}$ ), after which it tries to turn on again. If the short condition remains, the current limit circuit will limit the output current. The unit will return to normal operation once the fault condition is removed.

**Internal Over-Voltage Protection:** To fully protect from excessive output voltage, the unit contains an output over-voltage shutdown that is fixed at  $\sim 110\%$  of  $V_{max}$ . If this limit is reached, the converter shuts down and then waits an inhibit time ( $\sim 100\text{ms}$ ), after which it restarts.

**Over-Temperature Shutdown:** Two sensors in the module monitor the temperature of both the buck and boost sections. When the temperature at either sensor exceeds the Over Temperature Shutdown value, the converter is disabled. It will restart normally when it then cools by the amount of the Over-Temperature Shutdown Hysteresis.



## Application Section

### APPLICATION CONSIDERATIONS

**Input filtering:** These modules should be connected to a low-impedance source. A highly inductive source can affect the stability of the module. An input capacitor must be placed adjacent to the input pins of the module to minimize input ripple voltage and ensure stability. See SynQor's application note titled Input System Stability for guidance on selecting appropriate input filter elements.

[http://www.synqor.com/documents/appnotes/appnt\\_System\\_Instability.pdf](http://www.synqor.com/documents/appnotes/appnt_System_Instability.pdf)

**Output capacitance:** An output capacitor of at least 100uF with an ESR of ~50mOhms is recommended to damp the resonance of the output filter. More capacitance can be added to improve dynamic response to load variation; there is not upper limit on the value of the output capacitance. Very large output capacitors may slow the converter's start up time due to the current required to charge them being limited by current limit or Isetpoint.

**Current limit:** Available current is limited by maximum output current in buck mode ( $V_{in} > V_{out}$ ), and by maximum input current in boost mode ( $V_{in} < V_{out}$ ).

for  $V_{in} > V_{out}$

$$I_{limit} = 1.12 \times I_{max} \text{ (Amps)}$$

for  $V_{in} < V_{out}$

where  $I_{max}$  = Maximum rated output current

$$I_{limit} = 1.12 \times I_{max} \left( \frac{V_{in}}{V_{out}} \right) \text{ (Amps)}$$

### Generating Negative output voltage (inversion):

The circuit shown in Figure D can be used to generate a negative output voltage from a positive input.

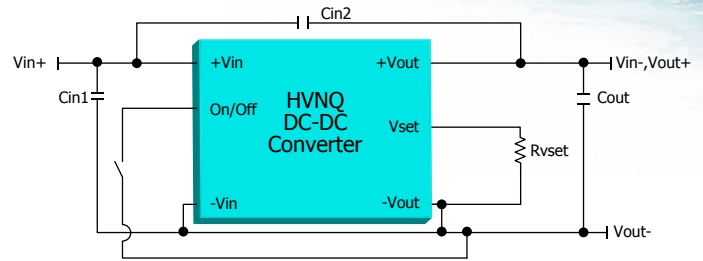

**Figure D:** Negative output setup

Note that all control signals are referenced to  $V_{out-}$ .



## Application Section

**Thermal Consideration:** The maximum operating baseplate temperature,  $T_B$ , is 100 °C. Refer to the Thermal Derating Curves in the Technical Figures section to see the available output current at baseplate temperatures below 100 °C.

$$P_{diss}^{max} = \frac{T_B - T_A}{R_{THBA}}$$

This value of maximum power dissipation can then be used in conjunction with the data shown in the Power Dissipation Curves in the Technical Figures section to determine the maximum load current (and power) that the converter can deliver in the given thermal condition. For convenience, Thermal Derating Curves are provided in the Technical Figures section.

A power derating curve can be calculated for any heatsink that is attached to the base-plate of the converter. It is only necessary to determine the thermal resistance,  $R_{THBA}$ , of the chosen heatsink between the baseplate and the ambient air for a given airflow rate. This information is usually available from the heatsink vendor. The following formula can be used to determine heatsink vendor. the maximum power the converter can dissipate for a given thermal condition if its base-plate is to be no higher than 100 °C.



**MCOTS-N-28V-60-EP**

**Output: 0 - 60V**

**Current: 15A**

### Standard Mechanical Diagram

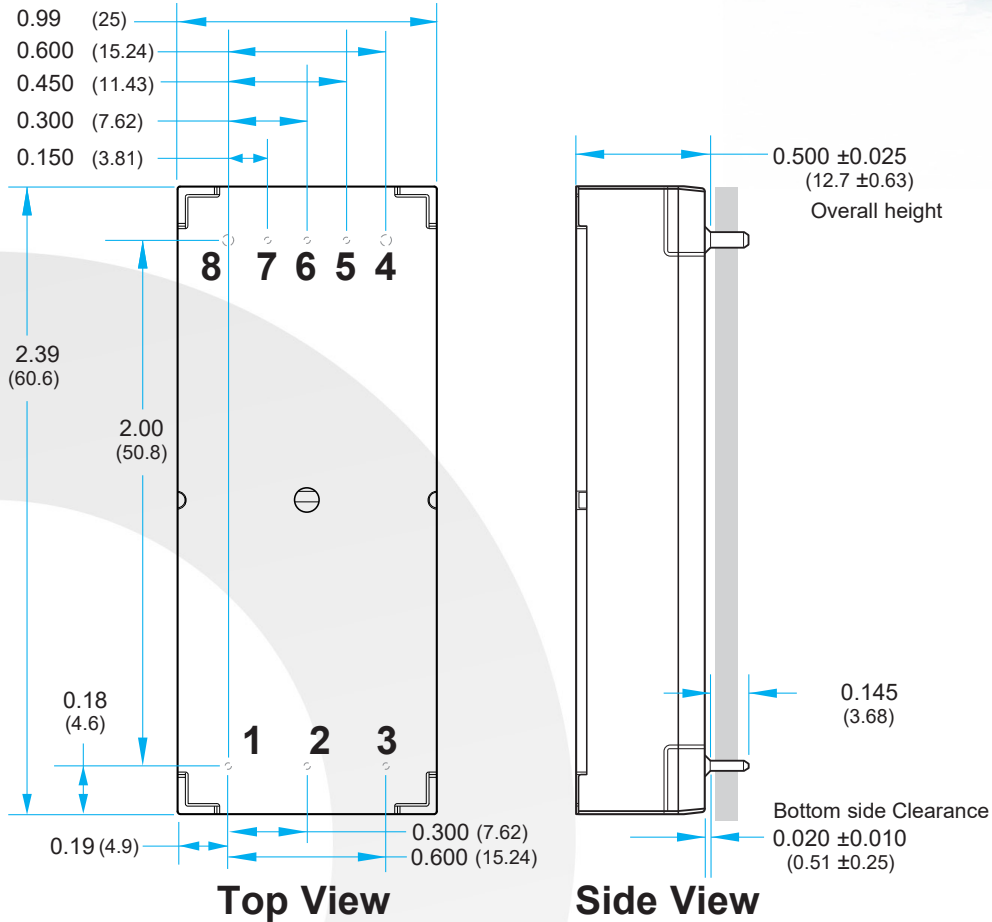

### NOTES

- 1)BASEPLATE FLATNESS TOLERANCE IS 0.004" (.10mm) TIR FOR SURFACE
- 2)PINS 1-3, 5-7 ARE 0.040" (1.02mm) DIA. WITH 0.080" (2.03mm) DIA. STANDOFF SHOULDERS
- 3)PINS 4 AND 8 ARE 0.062" (1.57mm) DIA. WITH 0.100" (2.54mm) DIA. STANDOFF SHOULDERS
- 4)ALL PINS: MATERIAL: COPPER ALLOY  
FINISH: MATTE TIN OVER NICKEL PLATE
- 5)UNDIMENSIONED COMPONENTS ARE SHOWN FOR VISUAL REFERENCE ONLY
- 6)ALL DIMENSIONS IN INCHES(mm)  
TOLERANCES: X.XXIN +/-0.02 (X.Xmm +/-0.5mm)  
X.XXXIN +/-0.010 (X.XXmm +/-0.25mm)
- 7)WEIGHT: 1.7oz (48g) TYPICAL
- 8)WORKMANSHIP: MEETS OR EXCEEDS IPC-A-610 CLASS II

### PIN DESIGNATIONS

Pin	Label	Function
1	+VIN	Positive Supply Input
2	ON/OFF	Input to enable/disable the converter, TTL
3	-VIN	Negative Supply Input, internally connected to Pin 4
4	-VOUT	Negative Supply Output, internally connected to Pin 3
5	Iset	Input to set the maximum output current.
6	Vset	Input to set the maximum output voltage.
7	Imon	Imon
8	+VOUT	Positive Power Output



## Flanged Mechanical Diagram

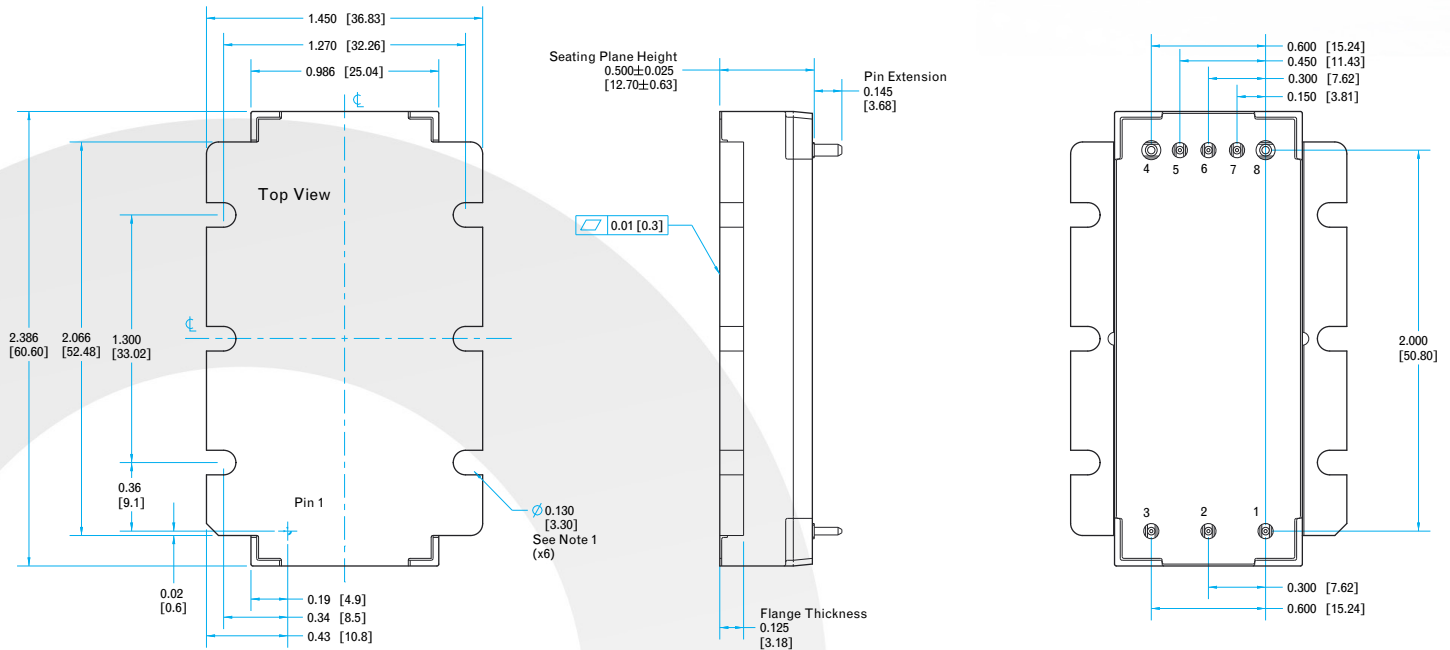

### NOTES

- Applied torque per screw should not exceed 6in-lb (0.7Nm).
- Baseplate flatness tolerance is 0.01" (.2mm) TIR for surface.
- Pins 1-3, 5-7 are 0.040" (1.02mm) diameter, with 0.080" (2.03mm) diameter standoff shoulders.
- Pins 4 and 8 are 0.062" (1.57 mm) diameter with 0.100" (2.54 mm) diameter standoff shoulders.
- All Pins: Material - Copper Alloy- Finish (RoHS 6/6) - Matte Tin over Nickel plate
- Weight: 1.9 oz (53g) Typical
- All dimensions in inches (mm)  
Tolerances: x.xx +/-0.02 in. (x.x +/-0.5mm)  
x.xxx +/-0.010 in. (x.xxx +/-0.25mm)
- Workmanship: Meets or exceeds IPC-A-610 Class II
- Recommended pin length is 0.03" (0.76mm) greater than the PCB thickness.
- A thermal interface material is required to assure proper heat transfer from the flanged baseplate to the cooling surface. Thermal grease may be used, or materials such as Thermalloy's Grafoil or Bergquist HiFlow and Softflow. Other similar products are available from many heatsink manufacturers.

### PIN DESIGNATIONS

Pin	Label	Function
1	+VIN	Positive Supply Input
2	ON/OFF	Input to enable/disable the converter, TTL
3	-VIN	Negative Supply Input, internally connected to Pin 4
4	-VOUT	Negative Supply Output, internally connected to Pin 3
5	Iset	Input to set the maximum output current.
6	Vset	Input to set the maximum output voltage.
7	Imon	Imon
8	+VOUT	Positive Power Output



**MCOTS-N-28V-60-EP**  
**Output: 0 - 60V**  
**Current: 15A**

## Qualifications & Screening

### Mil-COTS Qualification

Test Name	Details	# Tested (# Failed)	Consistent with MIL-STD-883F Method
Life Testing	Visual, mechanical and electrical testing before, during and after 1000 hour burn-in @ full load	15 (0)	Method 1005.8
Shock-Vibration	Visual, mechanical and electrical testing before, during and after shock and vibration tests	5 (0)	MIL-STD-202, Methods 201A & 213B
Humidity	+85 °C, 95% RH, 1000 hours, 2 minutes on / 6 hours off	8 (0)	Method 1004.7
Temperature Cycling	500 cycles of -55 °C to +100 °C (30 minute dwell at each temperature)	10 (0)	Method 1010.8, Condition A
Solderability	15 pins	15 (0)	Method 2003
DMT	-65 °C to +110 °C across full line and load specifications in 5 °C steps	7 (0)	
Altitude	70,000 feet (21 km), see Note	2 (0)	

Note: A conductive cooling design is generally needed for high altitude applications because of naturally poor convective cooling at rare atmospheres.

### Mil-COTS Converter and Filter Screening

Screening	Process Description	S-Grade	M-Grade
Baseplate Operating Temperature		-55 °C to +100 °C	-55 °C to +100 °C
Storage Temperature		-65 °C to +135 °C	-65 °C to +135 °C
Pre-Cap Inspection	IPC-A-610, Class III	•	•
Temperature Cycling	MIL-STD-883F, Method 1010, Condition B, 10 Cycles		•
Burn-In	100 °C Baseplate	12 Hours	96 Hours
Final Electrical Test	100%	25 °C	-55 °C, +25 °C, +100 °C
Final Visual Inspection	MIL-STD-883F, Method 2009	•	•

### Mil-COTS MIL-STD-810G Qualification Testing

MIL-STD-810G Test	Method	Description
Fungus	508.6	Table 508.6-I
Altitude	500.5 - Procedure I	Storage: 70,000 ft / 2 hr duration
	500.5 - Procedure II	Operating: 70,000 ft / 2 hr duration; Ambient Temperature
Rapid Decompression	500.5 - Procedure III	Storage: 8,000 ft to 40,000 ft
Acceleration	513.6 - Procedure II	Operating: 15 g
Salt Fog	509.5	Storage
High Temperature	501.5 - Procedure I	Storage: 135 °C / 3 hrs
	501.5 - Procedure II	Operating: 100 °C / 3 hrs
Low Temperature	502.5 - Procedure I	Storage: -65 °C / 4 hrs
	502.5 - Procedure II	Operating: -55 °C / 3 hrs
Temperature Shock	503.5 - Procedure I - C	Storage: -65 °C to 135 °C; 12 cycles
Rain	506.5 - Procedure I	Wind Blown Rain
Immersion	512.5 - Procedure I	Non-Operating
Humidity	507.5 - Procedure II	Aggravated cycle @ 95% RH (Figure 507.5-7 aggravated temp - humidity cycle, 15 cycles)
Random Vibration	514.6 - Procedure I	10 - 2000 Hz, PSD level of 1.5 g <sup>2</sup> /Hz (54.6 g <sub>rms</sub> ), duration = 1 hr/axis
Shock	516.6 - Procedure I	20 g peak, 11 ms, Functional Shock (Operating no load) (saw tooth)
	516.6 - Procedure VI	Bench Handling Shock
Sinusoidal vibration	514.6 - Category 14	Rotary wing aircraft - helicopter, 4 hrs/axis, 20 g (sine sweep from 10 - 500 Hz)
Sand and Dust	510.5 - Procedure I	Blowing Dust
	510.5 - Procedure II	Blowing Sand



**MCOTS-N-28V-60-EP**  
**Output: 0 - 60V**  
**Current: 15A**

**Ordering Information/ Part Numbering**

Example: MCOTS-N-28V-60-EP

Not all combinations make valid part numbers, please contact SynQor for availability. See [product summary page](#) for details.

Family	Product	Input Voltage	Output Voltage	Package	Thermal Design	Screening Level
MCOTS	N: Non-Isolated	28V: 9-60V 28VE: 9-90V	60:0-60V 90:0-90V	EP: Eighth Brick Peta	N: Normal Threaded F: Flanged	S: S-Grade M: M-Grade

**Application Notes**

A variety of application notes and technical white papers can be downloaded in pdf format from our website.

**Contact SynQor for further information and to order:**

**Phone:** 978-849-0600  
**Toll Free:** 888-567-9596  
**Fax:** 978-849-0602  
**E-mail:** [power@synqor.com](mailto:power@synqor.com)  
**Web:** [www.synqor.com](http://www.synqor.com)  
**Address:** 155 Swanson Road  
 Boxborough, MA 01719  
 USA

**PATENTS**

SynQor holds numerous U.S. patents, one or more of which apply to most of its power conversion products. Any that apply to the product(s) listed in this document are identified by markings on the product(s) or on internal components of the product(s) in accordance with U.S. patent laws. SynQor's patents include the following:

7,050,309 7,765,687 7,787,261  
 8,149,597 8,644,027

**WARRANTY**

SynQor offers a two (2) year limited warranty. Complete warranty information is listed on our website or is available upon request from SynQor.